

I enlarged view

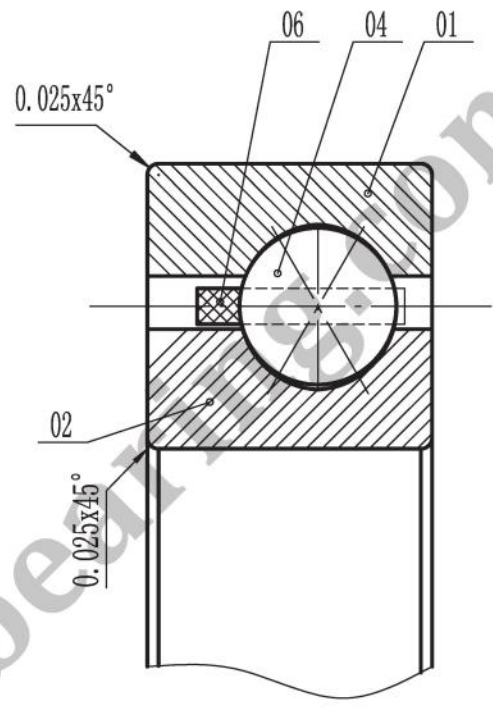

SILVER THIN SECTION BEARING

Formal drawing of SA065XP0 will be submitted after contact with:  
[sales@jcb-bearing.com](mailto:sales@jcb-bearing.com) or [sales@thinsectionbearings.com](mailto:sales@thinsectionbearings.com)

| 06  | cage        |      | Brass            |              |       |        |
|-----|-------------|------|------------------|--------------|-------|--------|
| 04  | steel ball  |      | AISI 52100 Steel |              |       |        |
| 02  | inner ring  | 1    | AISI 52100 Steel |              |       |        |
| 01  | outer ring  | 1    | AISI 52100 Steel |              |       |        |
| NO. | designation | qty. | material         | unit         | total | remark |
|     |             |      |                  | weight (lbs) |       |        |

Luoyang JCB Bearing Technology Co., Ltd  
 Contact information  
 Company Address : No.285 Fenghua road, Luoyang, Henan,China.  
 Postal code : 471000  
 Phone : 0086-379-68611678 Fax : 0086-379-68611679  
 E-mail: [sales@jcb-bearing.com](mailto:sales@jcb-bearing.com)  
 Reserved E-mail: [sales@thinsectionbearings.com](mailto:sales@thinsectionbearings.com)  
 Website: <http://www.jcb-bearing.com>  
<https://www.thinsectionbearings.com>

|   |  |        |              |
|---|--|--------|--------------|
| <b>SA065XP0</b>                         |  |        |              |
|   |  |        | weight (lbs) |
|   |  |        | 0.30         |
| total page 1                            |  | page 1 |              |
| Luoyang JCB Bearing Technology Co., Ltd |  |        |              |