

J11008XP0

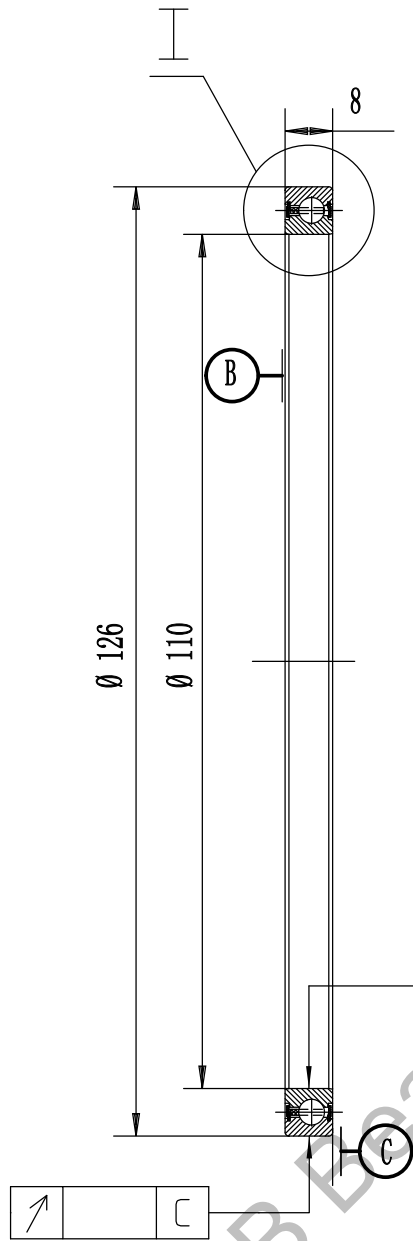

I enlarged view

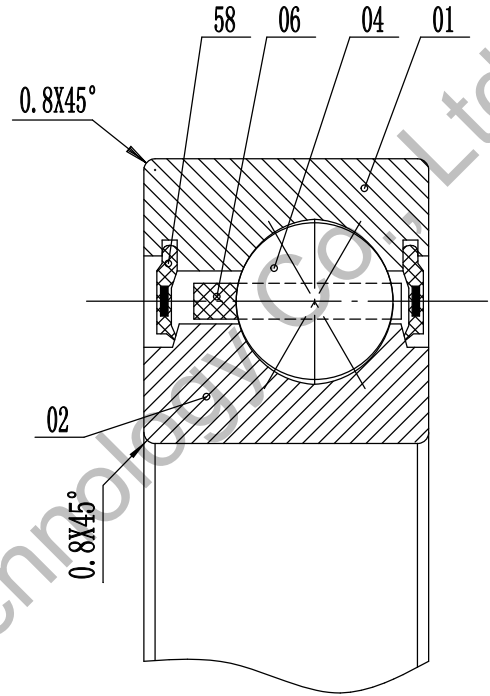

1. Radial clearance:



06	cage		Brass			
04	steel ball		AISI 52100 Steel			
02	inner ring	1	AISI 52100 Steel			
01	outer ring	1	AISI 52100 Steel			
No.	designation	qty	material	unit	total	remark
				weight (kg)		

Luoyang JCB Bearing Technology Co., Ltd
 Contact information
 Company Address : No.285 Fenghua road, Luoyang, Henan, China.
 Postal code : 471000
 Phone : 0086-379-68611678 Fax : 0086-379-68611679
 E-mail: sales@jcb-bearing.com
 Reserved E-mail: sales@thinsectionbearings.com
 Website: www.jcb-bearing.com
 www.thinsectionbearings.com

THIN SECTION BEARING

J11008XP0

weight(kg)

0.15

total page 1

page 1

Luoyang JCB Bearing Technology Co., Ltd