

I enlarged view

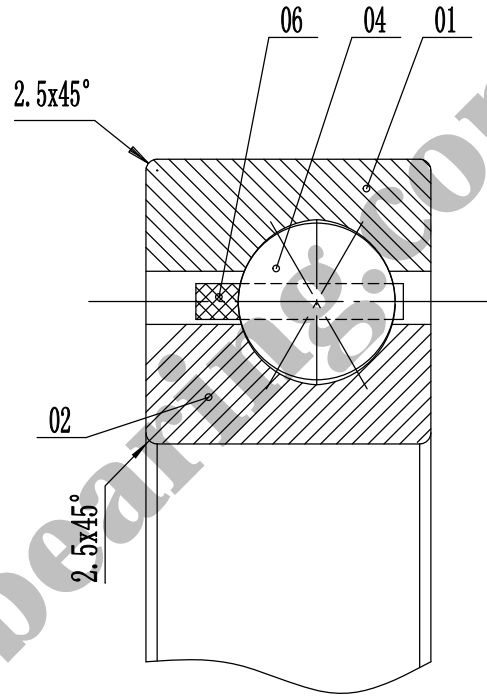

KAYDON THIN SECTION BEARING

Formal drawing of BB20025 will be submitted after contact with:  
[sales@jcb-bearing.com](mailto:sales@jcb-bearing.com) or [sales@thinsectionbearings.com](mailto:sales@thinsectionbearings.com)

06	cage		Brass			
04	steel ball		AISI 52100 Steel			
02	inner ring	1	AISI 52100 Steel			
01	outer ring	1	AISI 52100 Steel			
No.	designation	qty	material	unit	total	remark
				weight (kg)		
Luoyang JCB Bearing Technology Co., Ltd Contact information Company Address : No.285 Fenghua road, Luoyang, Henan,China. Postal code : 471000 Phone : 0086-379-68611678 Fax : 0086-379-68611679 E-mail: <a href="mailto:sales@jcb-bearing.com">sales@jcb-bearing.com</a> Reserved E-mail: <a href="mailto:sales@thinsectionbearings.com">sales@thinsectionbearings.com</a> Website: <a href="http://www.jcb-bearing.com">http://www.jcb-bearing.com</a> <a href="https://www.thinsectionbearings.com">https://www.thinsectionbearings.com</a>				<b>BB20025</b>		
					weight(kg)	
					3.4	—
				total page 1		page 1
				Luoyang JCB Bearing Technology Co., Ltd		